

PROJECT	_____
TYPE	_____
SPECIFIER	_____
QUANTITY	_____
DATE	_____

BIONIQ ROUND ADJUSTABLE RECESSED

A35224- _____

base number Color _____ Finishes _____
 Temperature (Diamond)

- To build a product code in our configurator select the specify button on the base model # product page
- To build a manual product code on this datasheet choose from the options listed below in blue font and add the suffix to the base model #

GENERAL

Series: Bioniq
 Subseries: Bioniq Round Adjustable
 Brand: Prolight
 Division: Architectural
 Mounting Type: Recessed
 Mounting Location: Ceiling
 Subcategory: Downlight

PHYSICAL

Shape: Round
 Diameter (mm): 107
 Diameter (in): 4 3/16
 Height (mm): 112
 Height (in): 4 7/16
 Ceiling Thickness (mm): 10 / 12.5 / 15
 Ceiling Thickness (in): 3/8 or 1/2 or 9/16
 Min. Recessing Depth (mm): 130
 Min. Recessing Depth (in): 5 1/8
 Light Distribution: Adjustable / Downlight
 Weight (kg): 0.47
 Weight (lbs): 1.04
 Fixture Finish: SSR / BKV / CWI / CRY / HAB / UFT / ITA / RUA / FTG / MYG / LOD / PUS / FRO / FUP / KIA / POP / BLS / SPG / MEY / GOH / GUM / CHC / COM / ABZ / JAG / OBR / MOS / ROR
 Fixture Material: Aluminum Die Cast
 Cut-out Measurements: 98mm / 3 7/8"

ELECTRICAL

Lamp Type: LED (Zhaga Standard)
 Input Wattage (W): 13.2 / 16.5
 Total Output Wattage (W): 12 / 15
 Dimming: Tri-Mode (Non-Dimming and Phase Dimming (120Vac only) and 0-10V Dimming)
 Driver Included: No
 Driver Location: Recessed Housing
 Driver Type: Constant Current - Universal
 Driver Class: Class 2
 Housing: See components
 Input Voltage (V): 120 - 277
 Constant Current (MA): 350

LED

Number of LEDs: 1
 Color Temperature (°K): 2700 / 3000 / 3500 / 4000
 Max. Delivered Lumen (lm): 850 / 950 / 1019 / 1040
 Nominal Lumen (lm): 960 / 1070 / 1156 / 1180
 CRI: >90 CRI
 Efficiency (%): 0.885
 Lamp Life (hrs): 50000

OPTICAL

Reflector°: 10
 Adjustability: Rotational 355°; Tilt 30°

RATINGS AND CERTIFICATIONS

Certified By: Certified for North American Standards
 IP rating: IP20



	98mm 3 7/8"	130mm 5 1/8"	10 15mm 3/8" 9/16"	30°	355°	

BIONIQ ROUND ADJUSTABLE RECESSED

A35224-

PROJECT	_____
TYPE	_____
SPECIFIER	_____
QUANTITY	_____
DATE	_____



A

PROJECT	_____
TYPE	_____
SPECIFIER	_____
QUANTITY	_____
DATE	_____

BIONIQ ROUND ADJUSTABLE RECESSED

A35236- _____ - _____

base number Color _____ Finishes _____
 Temperature (Diamond)

- To build a product code in our configurator select the specify button on the base model # product page
- To build a manual product code on this datasheet choose from the options listed below in blue font and add the suffix to the base model #

GENERAL

Series: Bioniq
 Subseries: Bioniq Round Adjustable
 Brand: Prolicht
 Division: Architectural
 Mounting Type: Recessed
 Mounting Location: Ceiling
 Subcategory: Downlight

PHYSICAL

Shape: Round
 Diameter (mm): 107
 Diameter (in): 4 3/16
 Height (mm): 112
 Height (in): 4 7/16
 Ceiling Thickness (mm): 10 / 12.5 / 15
 Ceiling Thickness (in): 3/8 or 1/2 or 9/16
 Min. Recessing Depth (mm): 130
 Min. Recessing Depth (in): 5 1/8
 Light Distribution: Adjustable / Downlight
 Weight (kg): 0.47
 Weight (lbs): 1.04
 Fixture Finish: SSR / BKV / CWI / CRY / HAB / UFT / ITA / RUA / FTG / MYG / LOD / PUS / FRO / FUP / KIA / POP / BLS / SPG / MEY / GOH / GUM / CHC / COM / ABZ / JAG / OBR / MOS / ROR
 Fixture Material: Aluminum Die Cast
 Cut-out Measurements: 98mm / 3 7/8"

ELECTRICAL

Lamp Type: LED (Zhaga Standard)
 Input Wattage (W): 13.2 / 16.5
 Total Output Wattage (W): 12 / 15
 Dimming: Tri-Mode (Non-Dimming and Phase Dimming (120Vac only) and 0-10V Dimming)
 Driver Included: No
 Driver Location: Recessed Housing
 Driver Type: Constant Current - Universal
 Driver Class: Class 2
 Housing: See components
 Input Voltage (V): 120 - 277
 Constant Current (MA): 350

LED

Number of LEDs: 1
 Color Temperature (°K): 2700 / 3000 / 3500 / 4000
 Max. Delivered Lumen (lm): 790 / 880 / 951 / 970
 Nominal Lumen (lm): 960 / 1070 / 1156 / 1180
 CRI: >90 CRI
 Efficiency (%): 0.885
 Lamp Life (hrs): 50000

OPTICAL

Reflector°: 10
 Optic°: Lens Pack - No Lens
 Adjustability: Rotational 355°; Tilt 30°

RATINGS AND CERTIFICATIONS

Certified By: Certified for North American Standards
 IP rating: IP20



	98mm 3 7/8"	130mm 5 1/8"	10 15mm 3/8" 9/16"	30°	355°	

BIONIQ ROUND ADJUSTABLE RECESSED

A35236-

PROJECT

TYPE

SPECIFIER

QUANTITY

DATE



PROJECT	_____
TYPE	_____
SPECIFIER	_____
QUANTITY	_____
DATE	_____

BIONIQ ROUND SEMI ADJUSTABLE RECESSED

A35290- _____

base number Color _____ Finishes _____
 Temperature (Diamond)

- To build a product code in our configurator select the specify button on the base model # product page
- To build a manual product code on this datasheet choose from the options listed below in blue font and add the suffix to the base model #

GENERAL

Series: Bioniq
 Subseries: Bioniq Round Semi Adjustable
 Brand: Prolicht
 Division: Architectural
 Mounting Type: Recessed
 Mounting Location: Ceiling
 Subcategory: Downlight

PHYSICAL

Shape: Round
 Diameter (mm): 107
 Diameter (in): 4 3/16
 Height (mm): 112
 Height (in): 4 7/16
 Ceiling Thickness (mm): 10 / 12.5 / 15
 Ceiling Thickness (in): 3/8 or 1/2 or 9/16
 Min. Recessing Depth (mm): 130
 Min. Recessing Depth (in): 5 1/8
 Light Distribution: Adjustable / Downlight
 Weight (kg): 0.488
 Weight (lbs): 1.08
 Fixture Finish: SSR / BKV / CWI / CRY / HAB / UFT / ITA / RUA / FTG / MYG / LOD / PUS / FRO / FUP / KIA / POP / BLS / SPG / MEY / GOH / GUM / CHC / COM / ABZ / JAG / OBR / MOS / ROR
 Fixture Material: Aluminum Die Cast
 Cut-out Measurements: 98mm / 3 7/8"

ELECTRICAL

Lamp Type: LED (Zhaga Standard)
 Input Wattage (W): 13.2 / 16.5
 Total Output Wattage (W): 12 / 14
 Dimming: Tri-Mode (Non-Dimming and Phase Dimming (120Vac only) and 0-10V Dimming)
 Driver Included: No
 Driver Location: Recessed Housing
 Driver Type: Constant Current - Universal
 Driver Class: Class 2
 Housing: See components
 Input Voltage (V): 120 - 277
 Constant Current (MA): 350

LED

Number of LEDs: 1
 Color Temperature (°K): 2700 / 3000 / 3500 / 4000
 Max. Delivered Lumen (lm): 850 / 950 / 1029 / 1050
 Nominal Lumen (lm): 960 / 1070 / 1156 / 1180
 CRI: >90 CRI
 Efficiency (%): 0.885
 Lamp Life (hrs): 50000

OPTICAL

Reflector°: 10
 Adjustability: Rotational 355°; Tilt 10°

RATINGS AND CERTIFICATIONS

Certified By: Certified for North American Standards
 IP rating: IP20



112mm 4 7/16"

Ø 95mm 3 3/4"

Ø 107mm 4 3/16"



BIONIQ ROUND SEMI ADJUSTABLE RECESSED

A35290-

PROJECT _____

TYPE _____

SPECIFIER _____

QUANTITY _____

DATE _____



PROJECT	_____
TYPE	_____
SPECIFIER	_____
QUANTITY	_____
DATE	_____

BIONIQ ROUND SEMI ADJUSTABLE RECESSED

A35302-

base number Color _____ Finishes _____
 Temperature (Diamond)

- To build a product code in our configurator select the specify button on the base model # product page
- To build a manual product code on this datasheet choose from the options listed below in blue font and add the suffix to the base model #

GENERAL

Series: Bioniq
 Subseries: Bioniq Round Semi Adjustable
 Brand: Prolicht
 Division: Architectural
 Mounting Type: Recessed
 Mounting Location: Ceiling
 Subcategory: Downlight

PHYSICAL

Shape: Round
 Diameter (mm): 107
 Diameter (in): 4 3/16
 Height (mm): 112
 Height (in): 4 7/16
 Ceiling Thickness (mm): 10 / 12.5 / 15
 Ceiling Thickness (in): 3/8 or 1/2 or 9/16
 Min. Recessing Depth (mm): 130
 Min. Recessing Depth (in): 5 1/8
 Light Distribution: Adjustable / Downlight
 Weight (kg): 0.452
 Weight (lbs): 1
 Fixture Finish: SSR / BKV / CWI / CRY / HAB / UFT / ITA / RUA / FTG / MYG / LOD / PUS / FRO / FUP / KIA / POP / BLS / SPG / MEY / GOH / GUM / CHC / COM / ABZ / JAG / OBR / MOS / ROR
 Fixture Material: Aluminum Die Cast
 Cut-out Measurements: 98mm / 3 7/8"

ELECTRICAL

Lamp Type: LED (Zhaga Standard)
 Input Wattage (W): 13.2 / 16.5
 Total Output Wattage (W): 12 / 14
 Dimming: Tri-Mode (Non-Dimming and Phase Dimming (120Vac only) and 0-10V Dimming)
 Driver Included: No
 Driver Location: Recessed Housing
 Driver Type: Constant Current - Universal
 Driver Class: Class 2
 Housing: See components
 Input Voltage (V): 120 - 277
 Constant Current (MA): 350

LED

Number of LEDs: 1
 Color Temperature (°K): 2700 / 3000 / 3500 / 4000
 Max. Delivered Lumen (lm): 790 / 880 / 950 / 970
 Nominal Lumen (lm): 960 / 1070 / 1156 / 1180
 CRI: >90 CRI
 Efficiency (%): 88.5
 Lamp Life (hrs): 50000

OPTICAL

Reflector°: 10
 Adjustability: Rotational 355°; Tilt 10°

RATINGS AND CERTIFICATIONS

Certified By: Certified for North American Standards
 IP rating: IP54

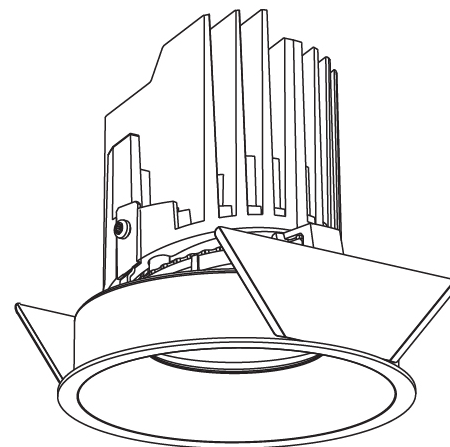

112mm 4 7/16"

Ø 95mm 3 3/4"

Ø 107mm 4 3/16"

A

BIONIQ ROUND SEMI ADJUSTABLE RECESSED

A35302-

PROJECT

TYPE

SPECIFIER

QUANTITY

DATE



PROJECT	_____
TYPE	_____
SPECIFIER	_____
QUANTITY	_____
DATE	_____

BIONIQ ROUND PINHOLE RECESSED

A37861- _____
 base number Color _____ Finishes _____
 Temperature (Diamond)

- To build a product code in our configurator select the specify button on the base model # product page
- To build a manual product code on this datasheet choose from the options listed below in blue font and add the suffix to the base model #

GENERAL

Series: Bioniq
 Subseries: Bioniq Round Pinhole
 Brand: Prolicht
 Division: Architectural
 Mounting Type: Recessed
 Mounting Location: Ceiling
 Subcategory: Downlight

PHYSICAL

Shape: Round
 Diameter (mm): 107
 Diameter (in): 4 3/16
 Height (mm): 112
 Height (in): 4 7/16
 Ceiling Thickness (mm): 10 / 12.5 / 15
 Ceiling Thickness (in): 3/8 or 1/2 or 9/16
 Min. Recessing Depth (mm): 130
 Min. Recessing Depth (in): 5 1/8
 Light Distribution: Adjustable / Downlight
 Weight (kg): 0.473
 Weight (lbs): 1.04
 Fixture Finish: SSR / BKV / CWI / CRY / HAB / UFT / ITA / RUA / FTG / MYG / LOD / PUS / FRO / FUP / KIA / POP / BLS / SPG / MEY / GOH / GUM / CHC / COM / ABZ / JAG / OBR / MOS / ROR
 Fixture Material: Aluminum Die Cast
 Cut-out Measurements: 98mm / 3 7/8"

ELECTRICAL

Lamp Type: LED
 Input Wattage (W): 13.2 / 16.5
 Total Output Wattage (W): 12 / 15
 Dimming: Tri-Mode (Non-Dimming and Phase Dimming (120Vac only) and 0-10V Dimming)
 Driver Included: No
 Driver Location: Recessed Housing
 Driver Type: Constant Current - Universal
 Housing: See components
 Input Voltage (V): 120 - 277
 Constant Current (MA): 350

LED

Number of LEDs: 1
 Color Temperature (°K): 2700 / 3000 / 3500 / 4000
 Max. Delivered Lumen (lm): 850 / 950 / 1019 / 1040
 Nominal Lumen (lm): 960 / 1070 / 1156 / 1180
 CRI: >90 CRI
 Lamp Life (hrs): 50000

OPTICAL

Reflector°: 10
 Adjustability: Rotational 355°; Tilt 30°

RATINGS AND CERTIFICATIONS

Certified By: Certified for North American Standards
 IP rating: IP20

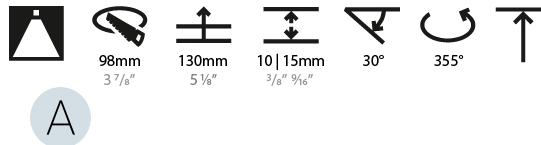
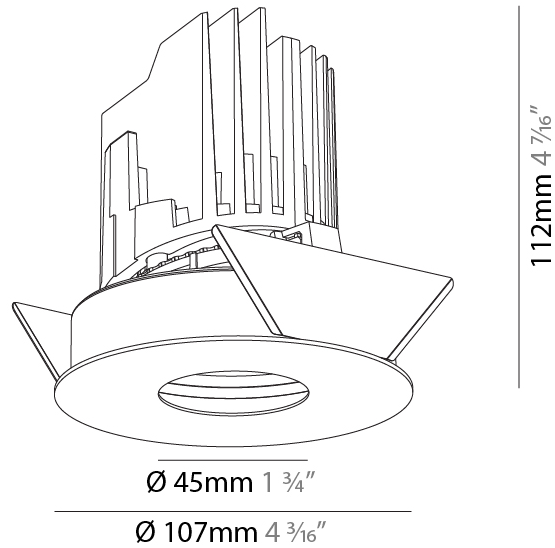

BIONIQ ROUND PINHOLE RECESSED

A37861-

PROJECT

TYPE

SPECIFIER

QUANTITY

DATE



PROJECT
TYPE
SPECIFIER
QUANTITY
DATE

Fixture Finish



Digital: Not all screens are calibrated the same, and therefore, colors will appear differently between screens.





































































Physical: When texture is involved, there will be variations in color, character and tone within a product series and between product families.

Gun Metal: No Gun Metal finish is alike. It combines a mixture of transparent and black color particles which ensures a highly individual effect and no luminaire being identical.

Champagne Cream, Copper Mine, Ancient Bronze + Jazz Gold: These finishes have slight fading from specific powder coating production. Each luminaire will slightly vary.



LEGEND

	floor-mounted		pivotal		special LED (upon request) RGB, RGBW, tunable, gold+, meat+, art+, fashion+
	wall and ceiling: recessed and surface mounted		rotating		warm dim / natural dimming LED
	ceiling-mounted and wall-mounted		illuminate tilted		rechargeable battery powered
	wall-mounted		color of suspension cable		fixture with natural vivid LED (upon request)
	omni-directional light distribution		length of suspension cable		color rendering index
	direct light distribution		reflector degree selection		color temperature
	direct/indirect light distribution		super spot		lumen (luminous flux)
	indirect light distribution		lens		efficacy (lumens per watt)
	asymmetric light distribution		lens pack		Unified Glare Rating (UGR) range from 5-40
	aura light distribution		shine ring		marine grade (AISI 316 stainless steel)
	round wall or ceiling cut-out		integrated shine ring with diffuser		walk on
	square wall or ceiling cut-out		free individual colors 01-29		drive on
	the supplied jig specifies the cutout dimensions		individual colors: 00 (free of charge), 01-25 (extra charge)		Dark Sky Compliance
	minimum distance (meters) lamp - object		luminaire part to be colored (F1)		Americans with Disabilities Act (less than 4" off the wall located between 27"-84" from floor)
	recessed depth		luminaire part to be colored (F2)		lamp protected against explosion
	ceiling thickness in mm		luminaire part to be colored (F3)		blown glass using traditional methods by master glass blower
	ceiling thickness selection		luminaire part to be colored (F4)		acoustic material
	dimnable DP (phase), DV (0-10V), DD (dali), DS (step-dim)		luminaire part to be colored (F5)		protection class I, protection insulation
	included or excluded LED driver/transformer/control gear		color of 3-circuit adaptor		protection class II, protection insulation
	separately switchable		indirect diffuser		ETL Certified to UL and CSA Standards
	sensor		direct diffuser		UL Certified to UL and CSA Standards
	remote control		ball-proof (upon request)		CSA Certified to UL and CSA Standards
	available upon request		accessory		Certified for North American Standards

IP RATING

	protected against ingress of solid bodies greater than 12.5mm (finger)
	protected against ingress of solid bodies greater than 2.5mm protected against sprays of water up to 60 degrees from the vertical (rain)
	protected against ingress of solid bodies greater than 1mm (wire) no protection against the ingress of moisture
	protected against ingress of solid bodies greater than 1mm (wire) protected against sprays of water up to 60 degrees from the vertical (rain)
	protected against ingress of solid bodies greater than 1mm (wire) protected against water splashed from all directions
	protected against limited ingress of dust (wet rooms/covered outdoor areas) protected against water splashed from all directions
	protected against ingress of dust protected against jets of water
	protected against ingress of dust protected against powerful jets of water or heavy seas
	protected against ingress of dust protected against immersion of water between 15cm - 1m for 30 minutes
	protected against ingress of dust protected against immersion of water under pressure for long periods

IK RATING

	protected against 0.14 joules impact (equivalent to 0.25kg mass dropped from 56mm above the surface)
	protected against 0.2 joules impact (equivalent to 0.25kg mass dropped from 80mm above the surface)
	protected against 0.35 joules impact (equivalent to 0.25kg mass dropped from 140mm above the surface)
	protected against 0.5 joules impact (equivalent to 0.25kg mass dropped from 200mm above the surface)
	protected against 0.7 joules impact (equivalent to 0.25kg mass dropped from 280mm above the surface)
	protected against 1 joules impact (equivalent to 0.25kg mass dropped from 400mm above the surface)
	protected against 2 joules impact (equivalent to 0.5kg mass dropped from 400mm above the surface)
	protected against 5 joules impact (equivalent to 1.7kg mass dropped from 300mm above the surface)
	protected against 10 joules impact (equivalent to 5.0kg mass dropped from 200mm above the surface)
	protected against 20 joules impact (equivalent to 5.0kg mass dropped from 400mm above the surface)